

32-7/8 IN. 60/40 BOWL APRON FRONT SINK

CA231232 (16 Gauge)

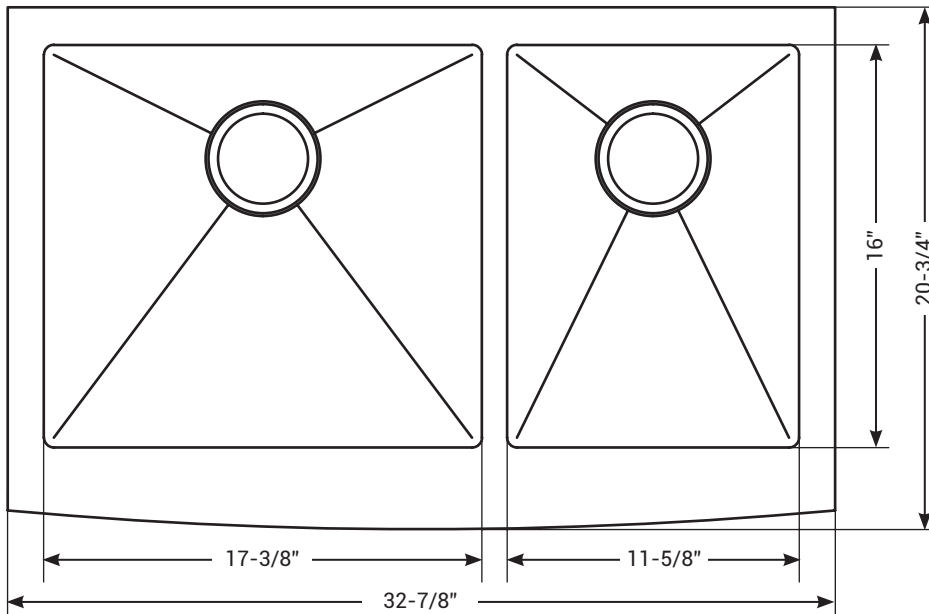
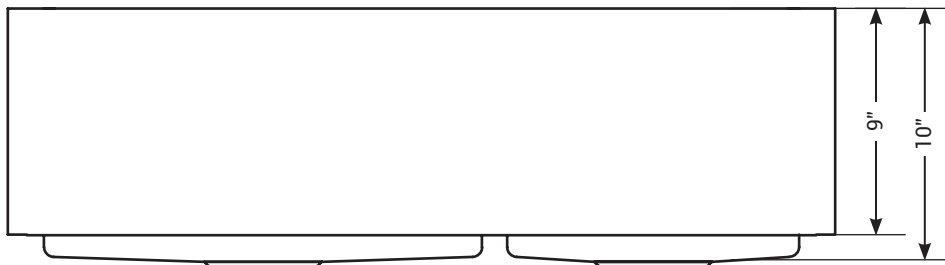

FEATURES

MODEL	CA231232
SIZE	32-7/8" W x 20-3/4" L
BOWL(S)	17-3/8" W x 16" L 11-5/8" W x 16" L
DEPTH	10", 10"
WEIGHT	47 lbs.
GAUGE	16 Gauge
MATERIAL	304 Series 18/10 CrNi Stainless Steel
DRAIN	Rear
MOUNT	Undermount

- Sound dampened with sprayed soundproof coating and an additional thick rubber soundproof pad
- Triple reinforced undermount panel
- Includes sink grid, drain assembly, mounting hardware, and cutout template
- Limited Lifetime Residential Warranty

BEFORE YOU BEGIN INSTALLATION

- Carefully Read the instructions before starting installation.
- This product should be installed by an experienced professional.
- Drain pipe is not supplied. Connect to an existing drain pipe.

If you are missing any part, please stop and contact us immediately at (205) 702-9101.

FOR WARRANTY ISSUES OR QUESTIONS, CONTACT CAHABA AT (205) 702-9101.

©2021 CAHABA. ALL RIGHTS RESERVED.

32-7/8 IN. 60/40 BOWL APRON FRONT SINK

Installation Instructions



PREPARE THE BASE CABINET

1. Apply painter's tape to the cabinets for marking and cutting purposes. This will protect the cabinet from damage while cutting.
2. Mark the front apron cut out on the painter's tape using the dimension of the apron front.
3. Using a sharp saw blade, carefully cut the cabinet on the traced line.

IMPORTANT: The cabinet must be installed, secured, plumb, and level BEFORE installing the sink.

IMPORTANT: Cahaba recommends providing the cabinet maker with the actual sink prior to cabinet fabrication. Before installing the sink, verify that the distance from the top of the doors to the top of the cabinet is greater than the apron front.

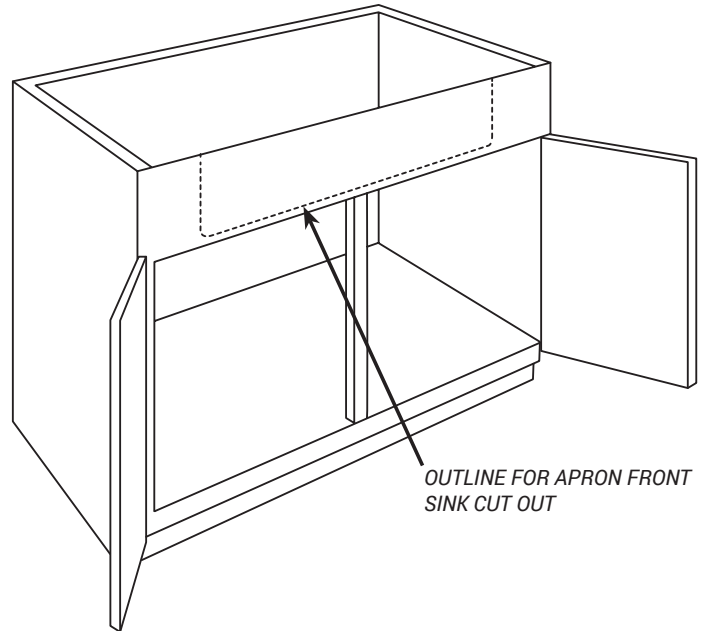

PREPARE THE COUNTERTOP

1. Position the template (provided with your sink) on the bottom of the counter top, flush to the front and centered; secure with tape. Trace the template and remove. Dry fit the sink to verify the measurements.
2. Following the counter top manufacturer's instructions, carefully cut the counter top on the traced line.

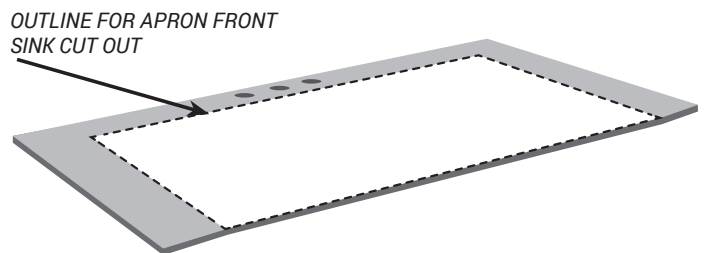

INSTALL THE SUPPORT FRAMING

1. Cut two lengths of support framing to extend horizontally along the inside walls on each side of the cabinet.
2. Measure and mark the support mounting locations; ensure the sink rim will sit at or slightly below the top of the cabinet.
3. Position and level the supports. Secure the supports with construction adhesive and screws (not provided).
4. Cut (4) lengths of support framing to extend from the bottom of the horizontal supports to the floor of the cabinet. Secure the vertical supports with construction adhesive and screws (not provided).

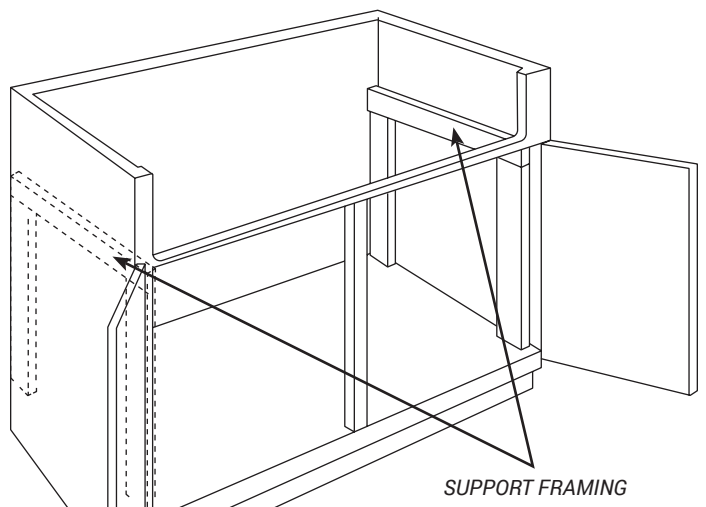

FOR WARRANTY ISSUES OR QUESTIONS, CONTACT CAHABA AT (205) 702-9101.

©2021 CAHABA. ALL RIGHTS RESERVED.

32-7/8 IN. 60/40 BOWL APRON FRONT SINK

Installation Instructions



INSTALL THE SUPPORT FRAMING (CONT.)

IMPORTANT: Long screws may damage adjacent cabinets. Ensure the screws are long enough to secure the support framing, but short enough not to go through the walls of adjacent cabinets.

IMPORTANT: Make sure the top of the sink does not extend above the top of the cabinet; otherwise it will interfere with counter top installation.

INSTALL THE SINK

1. Lower the sink onto the supports and verify the sink is supported by the frame.
2. Push the sink in to ensure the apron is flush to the front of the cabinet.
3. Verify the sink is level. Make any adjustments and shim as needed.
4. Secure the sink in place using the hardware provided

IMPORTANT: The front sink apron must be secured to the front of the cabinet by attaching fasteners through the cabinet front and into the support framing. Failure of this step can lead to product damage.

IMPORTANT: Cahaba is not responsible for sink or counter top if damaged during installation. Be sure to inspect the sink for damage prior to beginning installation.

IMPORTANT: Metal edges may be sharp – use caution when handling.

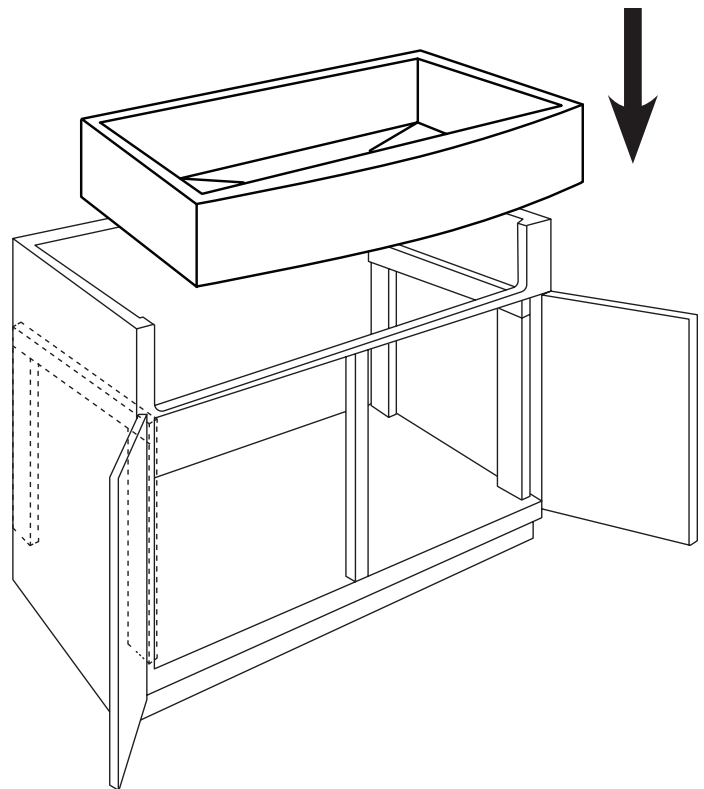

INSTALL THE COUNTERTOP

1. Clean the bottom of the counter top and the top flange (or lip) of the sink with denatured alcohol.
2. Apply a narrow bead of silicone adhesive sealant around the side and back of the sink.
3. Carefully position and secure the sink to the counter top following the manufacturer's instructions.
4. Apply a thin bead of silicone sealant where the sink meets the counter top and cabinet.
5. Immediately remove excess sealant.

APPLY SILICONE SEALANT AFTER CLEANING THE SINK EDGE AND COUNTERTOP

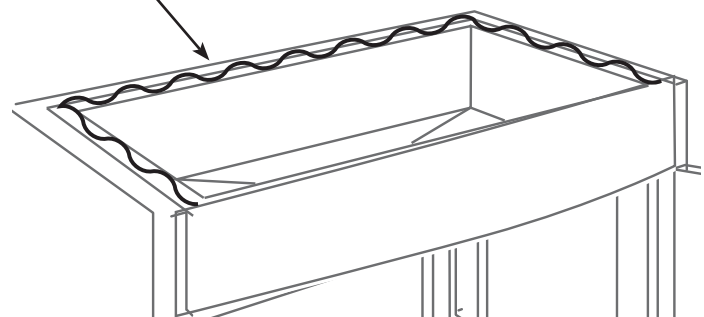

FOR WARRANTY ISSUES OR QUESTIONS, CONTACT CAHABA AT (205) 702-9101.

©2021 CAHABA. ALL RIGHTS RESERVED.

32-7/8 IN. 60/40 BOWL APRON FRONT SINK

Care & Maintenance



RECOMMENDED CLEANERS

For stains or light scratches, we suggest a mildly aggressive cleaner. You can also try a paste of baking soda and water, but be sure to rinse well and dry.

For stubborn stains and more noticeable scratches, we suggest a more aggressive cleaner such as Bar Keeper's Friend®. For extremely stubborn stains, you may also try to use a Scotch-Brite™ Pad. When using any of these cleaners, it is critical that you rub in the direction of the grain lines of the sink, rinse completely and towel dry.

SUGGESTED MAINTENANCE

- Rinse thoroughly after each use. Most soaps and detergents contain chlorides that are harsh on stainless steel. The good news is that chlorides are highly water soluble so a thorough rinsing of your sink after each use and weekly cleaning will keep your sink looking bright and shiny.
- Towel dry after each use to prevent mineral deposits from building upon the surface of the sink. Water quality can affect the appearance of your sink. Towel drying and weekly cleaning will prevent discoloration or unsightly film from developing on the finish.
- Always use the Cahaba sink bottom grid to protect your sinks finish.
- Clean the sink once a week. Be sure to rub in the direction of the satin finish lines, using a Cahaba recommended cleanser.
- For a gleaming finish: Polish your stainless steel sink by applying dry flour to the surface. Rub the flour in with a soft cloth, then rinse and dry or place the stopper in your sink, pour some club soda in and rub with a soft cloth. Dry with a different soft cloth to prevent water spots and surface rust.

CAUTION

- Don't rub the sink across the satin finish lines. Scouring across the satin finish lines can damage the original sink finish.
- Don't allow soap or other household cleansers to dry on the surface of the sink. Most brands contain chemical additives which will affect the original finish.
- Don't use solutions of chlorine bleach and water in the sink. Chlorides, which are found in most soaps, detergents, bleaches, and cleansers, are very aggressive to stainless steel. If left on the sink too long, they can cause surface pitting.
- Don't leave wet sponges, cloths, or cleaning pads on the sink. This can lead to surface rust. Don't use a steel wool pad to clean your sink. If a more abrasive product is needed, use a green Scotch-Brite™ pad, being sure to rub in the direction of the satin finish lines. Steel wool pads have a tendency to break apart and small particles of steel can become embedded in the surface of the sink. The steel particles will rust and will give the appearance that the sink itself is rusting.
- Don't use rubber mats or dishpans in the sink. Leaving rubber mats or dishpans in the sink can lead to surface rust or possible pitting. However, if you insist on using mats or dishpans, please remove them after each use and rinse thoroughly.

32-7/8 IN. 60/40 BOWL APRON FRONT SINK

Limited Lifetime Warranty



This product has been manufactured and tested to the highest quality standards by Cahaba. We offer our customers thoughtfully crafted fixtures & accessories, engineered for enduring performance over years of use.

WHO IS COVERED BY THE WARRANTY

This warranty extends to the original purchaser only. This warranty is not transferable, between homes or owners and is only applicable to residential use.

WHAT IS COVERED BY THE WARRANTY

Cahaba warrants this product against defects due to material or craftsmanship error during the warranty period: Cahaba will provide replacement parts at no charge, or at its option, replace any product or part of the product that is deemed defective, under normal installation, use, service and maintenance. If Cahaba is unable to provide a replacement and repair is not practical or cannot be made in timely fashion, Cahaba may elect to refund the purchase price in exchange for the return of the product.

CONDITIONS AND EXCLUSIONS

Like other home fixtures, Cahaba products will require light maintenance to ensure proper function. We provide you with complete knowledge to perform this maintenance and can also recommend resources if you are unable to fulfill this service.

- Cahaba will not be responsible for product failures due to lack of maintenance or proper use. Please read your care and maintenance documentation to determine the limits of proper use.
- The original sales receipt, order number, and/or proof of purchase must be presented at the time of the warranty claim, without exception, for this warranty to be applied to all Cahaba products.
- Cahaba recommends installing all Cahaba products with a licensed, professional plumber. Cahaba will not be held responsible for any damage or product failure due to improper installation, misuse, or failure to use a licensed professional. Please read your care and maintenance documentation to determine the limits of proper use.
- Commercial use will automatically void this warranty.

NON-APPLICABILITY OF THIS WARRANTY

By the purchase and use of our products, you agree that Cahaba is not liable for incidental, consequential or special damages associated with the return, replacement, installation or use of your product. This includes freight costs, cartridge replacement, labor, travel time, lost profit, home damages and other contingent liabilities and costs (including, without limitation, costs associated with experts, investigations, analyses, attorneys and other professionals and services).

The Cahaba warranty is a comprehensive and explicit limit of liability and all items outside of it are not addressable by or the responsibility of Cahaba. Certain states have variances regarding implied warranties and in those situations we remain fully compliant. Cahaba makes no implication that products comply with any or all local building or plumbing codes. It is the consumer's responsibility to determine local code compliance. This warranty extends to the original purchaser and first consumer.