

CAYLIN FREESTANDING TUB FAUCET

CA631001 (Polished Chrome)



FEATURES

MODEL	CA631001
SIZE	11-13/16" L x 6-1/8" W
HEIGHT	39-1/16" H
REACH	8-15/16 in. for Faucet; 60 in. for Handshower
FLOW	3.91 GPM for Spout / 1.61 GPM for Handshower
WEIGHT	9 lbs.
MATERIAL	Solid Brass
MOUNT	Freestanding

- Freestanding floor mount tub faucet with drip-free ceramic disc valve
- Lever handle diverter switches between faucet and handshower
- Includes handshower with 5 ft. hose and mounting hardware
- 1 Year Limited Residential Warranty

BEFORE YOU BEGIN INSTALLATION

- Carefully Read the instructions before starting installation.
- This product should be installed by an experienced professional.

If you are missing any part, please stop and contact us immediately at (205) 702-9101.

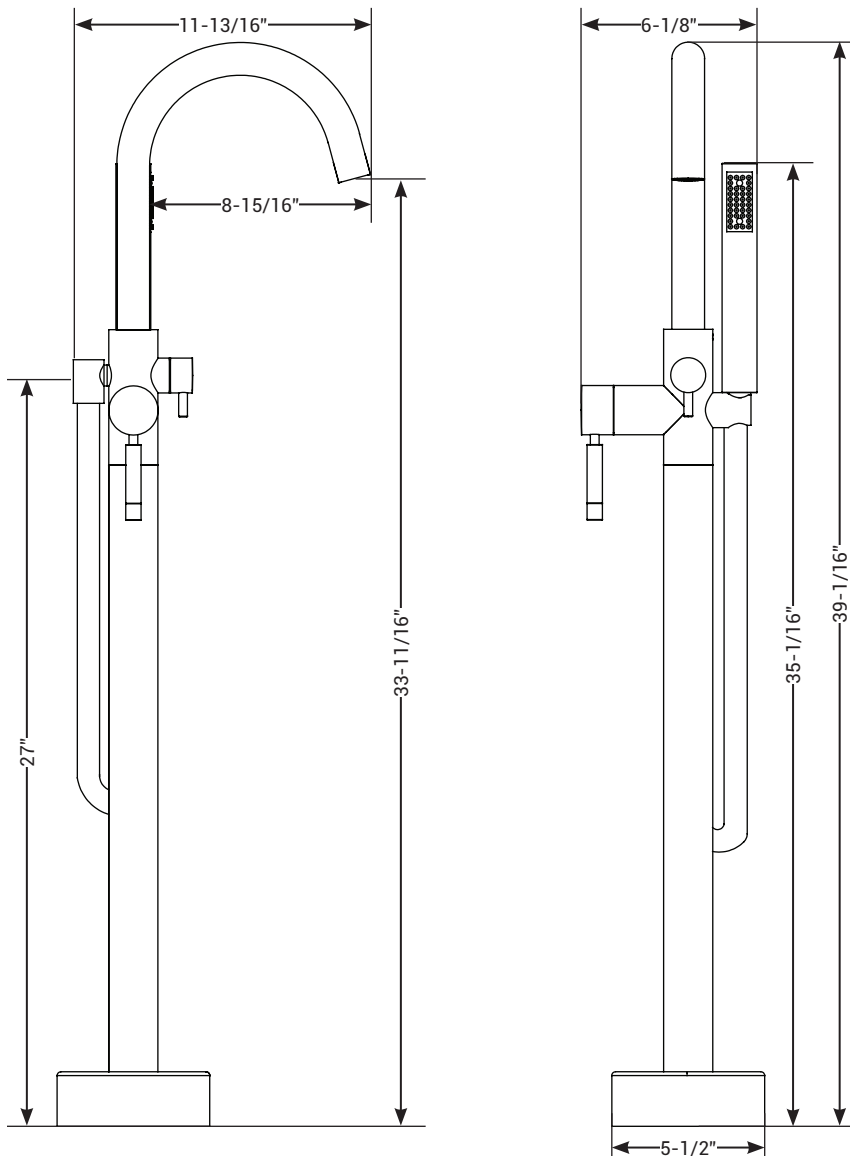

FOR WARRANTY ISSUES OR QUESTIONS, CONTACT CAHABA AT (205) 702-9101.

©2021 CAHABA. ALL RIGHTS RESERVED.

CAYLIN FREESTANDING TUB FAUCET

PARTS

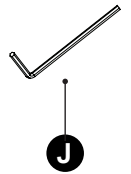
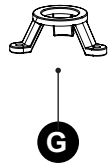
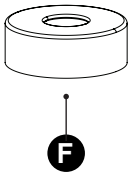
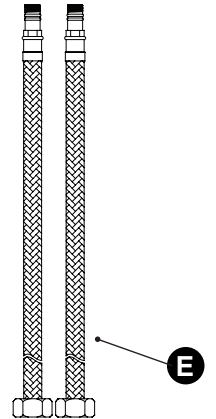
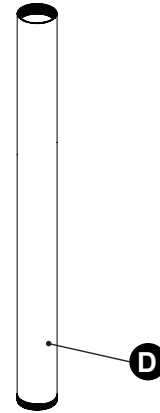
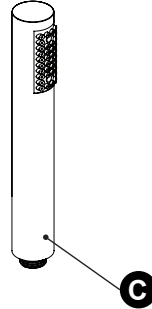
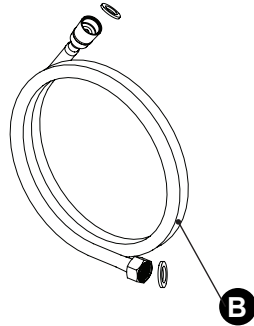
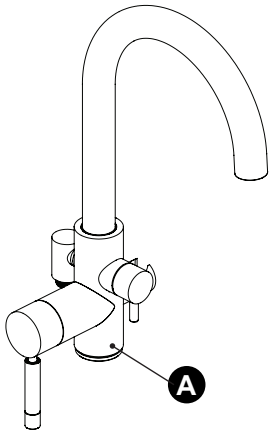

PART NO.	DESCRIPTION	QUANTITY
A	Spout	1
B	Shower hose	1
C	Hand Shower	1
D	Main tube	1
E	Supply hose	2

PART NO.	DESCRIPTION	QUANTITY
F	Decorative flange cover	1
G	Seat	1
H	Screws	3
I	Aerator's key	1
J	2.5mm Allen key	1

CAYLIN FREESTANDING TUB FAUCET

Installation Instructions



PRE-INSTALLATION AND OPERATION

Before beginning the installation, make sure the distance between the final resting place of the faucet and the bathtub is adequate:

- While opening and closing, the handle should not be blocked by the bathtub.
- When open, the water should fall straight down in the bathtub, not on the lip or on the floor.

FAUCET

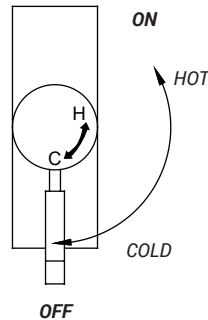

HANDSHOWER

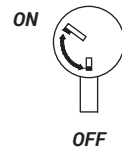

ASSEMBLE THE FAUCET

1. Attach the supply hoses to the spout. Use plumbers tape to ensure a tight seal and prevent leaks.

IMPORTANT: The hot side inlet tube is indicated by a label. Avoid twisting inlet tubes together.

2. Slide the main tube over the supply lines and secure it to the spout.
3. Slide the decorative flange cover over the main tube.
4. Attach the seat to the main tube.
5. Dry fit the faucet and check its position to the tub. Carefully mark the holes where the seat contacts the floor.

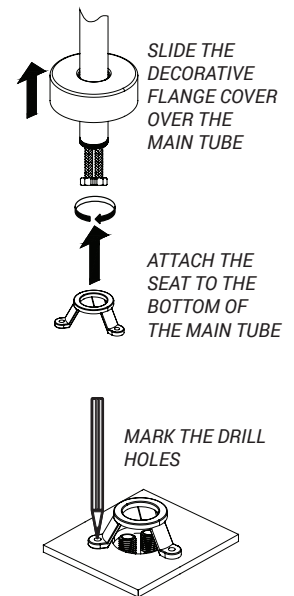
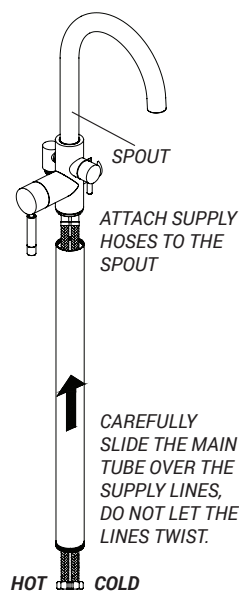

INSTALL THE FAUCET

1. Using a 10mm drill bit, drill previously marked holes.
2. Gently hammer the mounting screws into the holes
3. Thread the nut on the supply lines onto the outlet of the water supply valves. Do not overtighten.
4. Slide the seat in place, thread the nut onto the screws and tighten with a wrench. Do not overtighten.
5. Slide the decorative flange cover over the seat.
6. Attach the handshower.

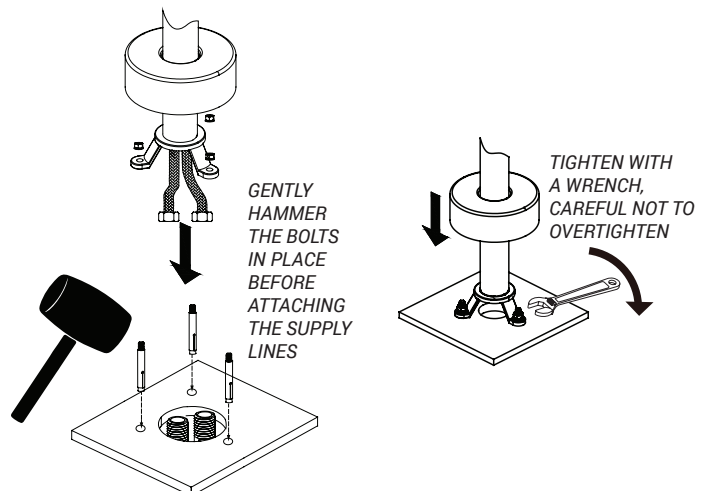

CAYLIN FREESTANDING TUB FAUCET

Installation Instructions



FINISHING

1. After installation is completed, turn on the hot and cold water supplies. Check for leaks.
2. Pull the hand shower out of the spout and remove the spray head by unscrewing it from the hose in a counterclockwise direction. Be sure to hold the end of the hose down into the tub and turn the tub faucet on to the warm position where it mixes hot and cold water.
3. Flush the water lines for one minute. This flushes away any debris that could cause damage to internal parts.
4. Check for leaks. Re-tighten any connections if necessary, but do not overtighten.
5. Reinstall the handshower by hand tightening it back onto the spray hose.

CAYLIN FREESTANDING TUB FAUCET

Care & Maintenance



Our tub fillers are engineered for superior performance inside and out. Following a regular cleaning schedule and understanding how to maintain your fixtures is key to keeping the finishes intact for years to come.

To maintain the luster of your tub filler we recommend wiping your faucet with a damp cloth and mild household cleanser. Dry with a soft cloth.

Remove hard water stains with a 50/50 solution of white vinegar and water. Rinse thoroughly with water afterward.

SUGGESTED MAINTENANCE

- To prevent the accumulation of mineral deposits, dry your fixtures with a soft cloth after each use
- To remove difficult mineral deposits on your handshower, unscrew it from the assembly. Soak it in a 50/50 vinegar and water solution for several hours. Rub stubborn deposits with a soft toothbrush. Rinse thoroughly and dry with a soft cloth.
- Applying carnauba wax to your fixtures is a great way to maintain the finish in the long-term because it helps prevent mineral deposits and other buildup. Whether you have oil rubbed bronze or chrome fixtures, apply wax twice annually to maintain them.

CAUTION

- DO NOT clean your tub filler, supply lines or drains with any type of abrasive cleaner. Although your fixture's finish is extremely durable, it can be damaged or scratched by harsh cleaners or abrasives. Avoid the following:
 - Products that state on the label that they remove tarnish and rust
 - Products containing hydrofluoric, hydrochloric and/or phosphoric acids and caustic agents
 - Industrial cleaners,
 - Abrasive cleaners
 - Toilet bowl cleaners
 - Bleach-based cleaners
 - Polish
 - Ammonia solutions
 - Heavy-duty scrub sponges
- DO NOT use drain cleaners, since they could strip the finish from the drain. If you have to, remove the drain pop-up and pour the cleaner carefully so that it touches only the plumbing it's being poured into.

CAYLIN FREESTANDING TUB FAUCET

Limited 1-Year Warranty



This product has been manufactured and tested to the highest quality standards by Cahaba. We offer our customers thoughtfully crafted fixtures & accessories, engineered for enduring performance over years of use.

WHO IS COVERED BY THE WARRANTY

This warranty extends to the original purchaser only. This warranty is not transferable, between homes or owners and is only applicable to residential use.

WHAT IS COVERED BY THE WARRANTY

Cahaba warrants this product against defects due to material or craftsmanship error during the warranty period: Cahaba will provide replacement parts at no charge, or at its option, replace any product or part of the product that is deemed defective, under normal installation, use, service and maintenance. If Cahaba is unable to provide a replacement and repair is not practical or cannot be made in timely fashion, Cahaba may elect to refund the purchase price in exchange for the return of the product.

CONDITIONS AND EXCLUSIONS

Like other home fixtures, Cahaba products will require light maintenance to ensure proper function. We provide you with complete knowledge to perform this maintenance and can also recommend resources if you are unable to fulfill this service.

- Cahaba will not be responsible for product failures due to lack of maintenance or proper use. Please read your care and maintenance documentation to determine the limits of proper use.
- The original sales receipt, order number, and/or proof of purchase must be presented at the time of the warranty claim, without exception, for this warranty to be applied to all Cahaba products.
- Cahaba recommends installing all Cahaba products with a licensed, professional plumber. Cahaba will not be held responsible for any damage or product failure due to improper installation, misuse, or failure to use a licensed professional. Please read your care and maintenance documentation to determine the limits of proper use.
- Commercial use will automatically void this warranty.

NON-APPLICABILITY OF THIS WARRANTY

By the purchase and use of our products, you agree that Cahaba is not liable for incidental, consequential or special damages associated with the return, replacement, installation or use of your product. This includes freight costs, cartridge replacement, labor, travel time, lost profit, home damages and other contingent liabilities and costs (including, without limitation, costs associated with experts, investigations, analyses, attorneys and other professionals and services).

The Cahaba warranty is a comprehensive and explicit limit of liability and all items outside of it are not addressable by or the responsibility of Cahaba. Certain states have variances regarding implied warranties and in those situations we remain fully compliant. Cahaba makes no implication that products comply with any or all local building or plumbing codes. It is the consumer's responsibility to determine local code compliance. This warranty extends to the original purchaser and first consumer.